



# VIBOCOLD<sup>®</sup>

MORE THAN COOL



VIBOCOLD A/S | Holstebrovej 101 | DK-8800 Viborg  
Service | Tlf. +45 8750 3419 | [service@vibocold.dk](mailto:service@vibocold.dk)

## TABLE OF CONTENTS:

1.	Safety.....
2.	User guide.....
2.1	Installation and mounting.....
2.2	Cleaning after mounting.....
2.3	Product start-up.....
2.4	Usage.....
2.5	Cleaning.....
2.6	Service.....
2.7	Technical info.....
2.8	Proper exploitation rules of refrigeration device.....
3.	Service manual.....
3.1	Control Panel – technical information.....
3.2	Electrical chart.....
3.3	Parameters setup.....

## 1. Safety



The device is designed to be operated by adults only. The child play in the vicinity of the working device is inadmissible, all the more using the device in operation to play.

### Live components

This symbol placed on a component or on a cover indicates the presence of live details. Component or cover can only be detached by an authorized service technician.

### Putting up

If there is no inspection window at the back of the appliance, it shall be placed with its rear part against the wall. Connect the power cord only when the appliance is put into place.

### Transport

Before you move the appliance always pull out the power cord. Otherwise there is a risk that the cable will be stretched and damaged, which can result in short circuit. Wear gloves while transporting the appliance because there may be sharp edges at the back of it.

### Cleaning

Always pull out the power cord before you clean the appliance because there is a risk of coming close to voltage or rotating fans e.g. during cleaning of the condensers or during removing dust from compressor tank.

### Storage

Store only the products that are intended for storage in the appliance. Never store explosive gases or liquids, they can do harm to a person or property. Never store products in glass packaging in the freezer compartment because the glass may crack.

### Children

Keep an eye on children and make sure that they cannot reach the control panel, voltage, and that they cannot get locked inside the appliance. Do not allow children to play with packing's. Cling film may bear risk of choking!

### Handing over or disposal

Do not throw out the operating instructions as they shall be provided in case of handing over or disposing the appliance.

### Discarding old appliances

Cut off the power cord as close to the appliance as possible. Remove the doors so that playing children cannot be locked inside. The appliance shall be left at a place where recyclable electrical and electronic components are collected. For further information about recycling, contact local authorities or the vendor of the appliance.

### Service

Always pull out the power cord before starting the service. The lights on the appliance and on the showcases are connected in such a way that the current does not break through the main switch.

### It is forbidden to:

- connect the device to mains without ensuring of efficient equipotential switch system,
- store spoiled products,
- place warm products inside working chamber of refrigerating device,
- place unfrozen products to freezing device,
- cover and block the ventilation holes of the device,
- tilt the device more than 45°, but if it was necessary, wait about 1 hour before starting the device,
- allowing the compressor oil to flow down,
- store delicatessen products without packaging for more than 3 days,
- store the products causing accelerated corrosion process (acids, bases),
- lift and transport the refrigerator counters holding them by plastic edges,
- place the shelves in drafts,
- place the devices near heat sources.
- in devices, the interior of which is finished with aluminum it is forbidden to store food products of acidic character. Use only the devices made of acid-resistant steel for this purpose.

## 2. User guide

Read through this user guide carefully. However, it is not necessary that You as a user, study the 3rd part of this document, the SERVICE MANUAL, which is intended for service staff.

### 2.1. Installation and mounting

#### Transport

It is recommended to transport the appliance to its mounting place using a transport packaging. Avoid tilting the appliance during transport. If the appliance has been tilted significantly, wait 15 minutes before turning it on and let the compressor oil flow down to its initial position.

#### ATTENTION !!

During transport and relocation, do not tilt the device more than 45°, because this can cause damage to the compressor.

#### Unpacking

Unpack the appliance out of the transport packaging and remove white plastic elements its shelves and walls.

Check if the appliance is not damaged. Any damages shall immediately be reported to the supplier.

#### Mounting/putting into place

The appliance is intended to be used in indoor spaces. Pay attention that the bottom construction is not be damaged, shall any mechanical tools be used to put the appliance into place.

In order to guarantee smooth operation and low energy consumption, it is recommended not to place the appliance close to units or elements that generate heat, or in places directly exposed to sunshine or draught, e.g. a draught from doors, air-conditioners or fans (A; B; C illustrations)

The appliance in its standard version produces the estimated temperature at the ambient temperature between +15 and +25 °C and relative humidity not exceeding 55 %,and climate class 3 according to the European norm EN 441, unless stated otherwise.

During installation proper ventilation shall be provided to the element of the chiller which generates heat, and in order to allow the evaporation of melt water.

The appliance shall be adjusted so that its placed as horizontally as possible. Maximum tilt can reach  $\pm 0,5$  degrees.

Check if all legs are placed properly on the floor in order to ensure smooth operation of doors and locks.

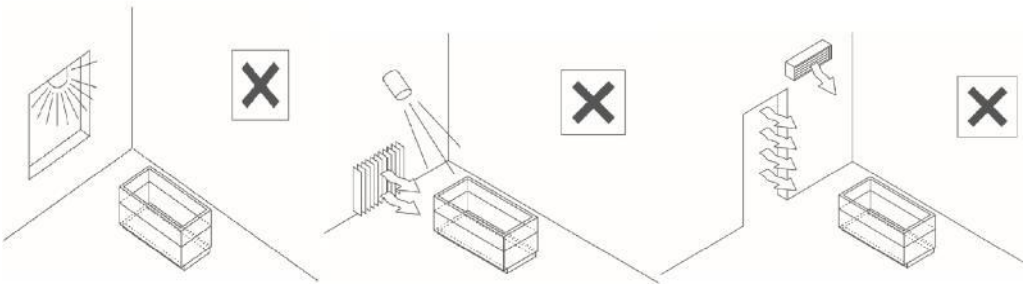

### 2.2. Cleaning after mounting

#### Cleaning

Dry the appliance on the inside and outside before you start using it. Use a neutral detergent. If you use another detergent, finish the cleaning with a neutral one. See section 2.5 Cleaning.

### 2.3. Product start-up

#### Temperature

If the appliance has been stored in an unheated space so that the temperature of the machinery was below 0 degrees, before the appliance is started it must be stored in an indoor space until the compressor temperature reaches +10 degrees, otherwise the compressor could be damaged.

## Start-up

The appliance can be started for the first time 3 hours after it has been put into place. Connect the appliance to mains power using a protective earth socket. The device should be powered from separate low-voltage circuit equipped with protective cord and protected with fuse up to 10 A (shelves up to 16A). Before connecting mains to the device check the local voltage is compatible with the appliance's requirements (data on rating plate). Start the appliance using the switch. The temperature of the appliance decreases and reaches the value set in the factory default settings. The products shall not be put into the appliance before the default value is reached.

### ATTENTION !!

1. It is not allowed to switch the device on without efficient equipotential switch system!!! The device is equipped with protective PE cord.
2. Connecting the device to electrical network should be done in such a way that the plug is visible and easily accessible for service. It is inadmissible to use extensions and branch-joints!!!
3. Before commencing any maintenance or cleaning activities, switch the device off, and then remove the plug from power outlet.

Eventual repairs of electrical installation and replacement of power cord can be done only by certified electrician.

## 2.4. Usage

### General information

Proper storage of products in both the fridge and freezer compartments are of great importance for their quality and freshness.

### Destination

Fridges are designed for short-term storing of foiled food products, like: dairy and pork-butcher's products, salads etc., as well as beverages and processed food. Freezer are designed for storing of food products as above, previously frozen. Refrigeration level raisers are designed for dispensing and short-term storing of various vegetable salads. The salads held in specially designed containers. The interior of the level raiser and containers are made of food-contact acid-resistant steel. The device can be used in groceries, bars, restaurants and gastronomic sites.

### Proper operation

- After receiving the device, check its technical condition and equipment according to the operating instruction; report possible damage to the seller within 24 hours.
- Level the device in the operating place, if it is wheeled, block the brakes.
- Maintain the device in good technical condition.
- Do not overload the device, i.e. watch the load to be compliant with technical data, watch the admissible payload of shelves.
- Fill the refrigerating / freezing device interior after its initial cooling.
- Clean the device interior with water solution of dish washing liquid, using soft cloth or sponge, previously switching off the mains.
- Use only the equipment delivered with refrigerating device.
- In case of damage, disconnect mains and call service.
- The producer suggests training of the personnel operating the device in the range of device operation, as well as in the range of basic issues of safety and hygiene of work.
- Connect the device to the mains network equipped with efficient equipotential switch system.
- The compartment that is intended for cold storage of products shall be filled with products taken directly from a fridge compartment (+4 degrees).
- Fridge – Do not fill it with products taken directly from a freezer compartment.
- Do not keep the doors open if this is not necessary.
- Do not store rotten products.
- If necessary, dry the moisture that may appear on shelves or walls inside the appliance.
- Check the temperature every day.
- Fridge – Always store products in closed containers or wrapped in cling film. In this way you can avoid ice building up or corrosion of the evaporator.
- Store products so that enough ventilation is provided.

- The products shall not be stored directly at the bottom of the fridge, but on the shelves.
- Furthermore, the products shall not be stored densely at the rear wall of the fridge, but there should always be a space left between the products and the wall, for the air to pass through.
- The compartment that is intended for storage of frozen products should be filled with products taken directly from freezer compartment (-18 degrees).
- Freezer – Store products in packing's appropriate for freezing.

Note! It is particularly important to cover the food that contains lots of salt or acid when storing it in the fridge compartment.

## CONTROL PANEL: DISPLAY

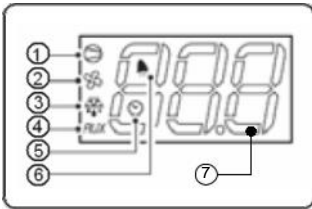

BUT. NO.	FUNCTION	NORMAL OPERATION			START UP
		ON	OFF	FLASH	
1	compressor 1/2	on	off	call	ON
2	fan	on	off	call	ON
3	defrost	on	off	call	ON
4	auxiliary output (AUX) - light	output active	output not active	-	ON
5	clock (RTC)	RTC available, enabled (tEN=1) and at least one time band has been set	RTC not available or not enabled (tEN=0) or no time band set	-	ON [if the clock is fitted]
6	alarm	alarm in progress	no alarm in progress	-	ON
7	digits	three digits with decimal point and range - 199 to 999. See parameters 4/5/6 for the type of probe displayed, values in C/F and decimal point.			

## CONTROL PANEL: KEYPAD

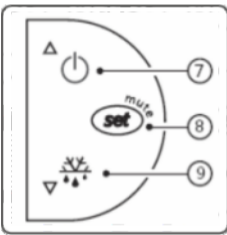

BUT. NO.	NORMAL OPERATION		START UP
1	more than 3s; switch ON/OFF light (H1=4) or defrost	pressed together with 3 activates / deactivates the continuous cycle or defrost (see parH6)	-
2	- 1s; displays / sets the set point - more than 3s; accesses the parameter setting menu [enter password 22] mutes the audible alarm (buzzer)	-	pressed together [2 and 3] activate parameter reset procedure
3	more than 3s; activates / deactivates light (H1=4) or defrost	pressed together with 1 activates / deactivates the continuous cycle or defrost (see parH6)	ON

All controls are coded during the delivery of the appliance. This code is necessary to adjust the settings. The desired value can be adjusted by <LSE; HSE> without typing the code. The code and parameters LSE, HSE can be found on the parameter list.

### Temperatures – Fridge

The products will have a temperature between 0 and +4 °C if, during its installation, the panel is set to the value within the range

0 and +4 °C. The fridge is automatically defrosted every four hours, cooling well every 4 hours (details – see Control unit documentation in section 3 of the Service manual). During automatic defrosting the LED

diode  is permanently on.

### Temperatures – Freezer

The products will have a temperature between -18 and -22 °C if, during its installation, the panel is set to the value within the range -18 and -22 °C. The freezer is automatically defrosted every four hours (details – see Control unit documentation in section 3 of the Service manual). During automatic defrosting the LED

diode  is permanently on.

## 2.5. Cleaning

Before commencing any maintenance or cleaning activities, switch the device off, and then remove the plug from power outlet!!! All repairs and maintenance should be performed by authorized personnel only. You should absolutely protect yourself against accidental switching the device on by unaware persons.

### Usage

How often the appliance needs to be cleaned depends on how frequently it is used and what types of products are usually stored in there.

### Detergents

Dry the appliance on the inside and outside. Use a neutral detergent. If you use another detergent, finish the cleaning with a neutral one.

### The following detergents are not to be used:

- detergents that contain chloride
- detergents that contain hypochlorite
- detergents for polishing silver
- see also the next point

### Products with PMMA details

During cleaning the details made of PMMA material, only a mild soap solution may be used. Warranty does not cover the usage of other detergents.

### Amount of water

Avoid using too much water because the electrical components could be damaged. It is strictly forbidden to shower the water directly on the outside or inside of the appliance.

### Condensers

Condensers should be cleaned at least once every three months or even more often, if the appliance is used under dusty conditions. Before cleaning, the power supply should be switched off and the plug should be pulled out of the wall socket. During cleaning a Hoover or a soft brush may be used. If the condenser is brushed, make sure that the aluminum disks will not be damaged.

### Drip slides

Check that the drip slide drain pipe is not clogged with dirt or dust. How often this must be done depends on how frequently the appliance is used.

### Cooling compartment

In case of daily usage the inside of cooling compartment shall be cleaned at least once a week, otherwise there is a risk that acids or salts may damage the inside of the appliance.

## 2.6. Service

While servicing the appliance and the showcases, the cable cord shall be pulled out. The transformer's power supply is connected in such a way that it does not break after turning off the appliance using the switch.

## 2.7. Technical info

WYMIARY / DIMENSIONAL PROPERTIES		0.6	1.0	1.4
DLUGOŚĆ BEZ BOKÓW / LENGTH WITHOUT END-WALLS	mm	548	894	1394
WYSOKOŚĆ / HEIGHT	mm	1365		
GLEBOKOŚĆ / DEPTH	mm	755		
GRUBOŚĆ BOKU / WALL THICKNESS	mm	28		
POWIERZCHNIA EKSPOZYCYJNA / HORIZONTAL DISPLAY AREA )	m <sup>2</sup>	0,9	1,4	2,3
POJEMNOŚĆ UŻYTKOWA / NET VOLUME <sup>1)</sup>	dm <sup>3</sup>	115	190	290
TDA (TOTAL DISPLAY AREA <sup>2)</sup>	m <sup>2</sup>	0,6	0,95	1,45
MAX. OBCIĄŻENIE PÓLEK / MAX. SHELF LOAD	kg/m <sup>2</sup>	75		
MAX. OBCIĄŻENIE PÓLEK ZAWIESZANYCH / MAX. HANGING SHELF LOAD	kg/m <sup>2</sup>	15		
WAGA / WEIGHT	kg			
POZIOM HAŁASU / NOISE LEVEL	dB (A)	≤60		

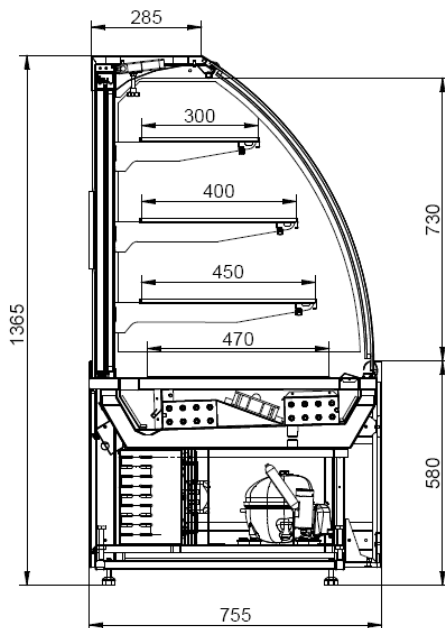

## 2.8. Proper exploitation rules of refrigeration device

1. Connect the device only do the zeroed mains outlet.
2. Place the device in a proper distance from the wall, described in operating instruction.
3. Do not cover intake and outlet holes in aggregate chamber, serving the circulation of air cooling the condenser.
4. Provide operating refrigeration device with the environment temperature in the following ranges: +15 to +25 °C
5. Place the device in a dry and drafty room (recommended relative humidity +55%).
6. Periodically, make the condensate outflow channels permeable by cleaning the trays and troughs.
7. In devices with no automatic defrosting, do a manual defrosting when the layer of frost on the evaporator exceeds 0.5 cm.
8. You should unconditionally dust the condenser fins in the aggregate chamber to provide free airflow, at least every three months.
9. Do not exceed chamber load capacity of refrigeration device given in operating instruction.
10. Observe the other suggestions and recommendations given in operating instruction.

### ATTENTION !!

Non-observance of the suggestions given above may result in non-reaching the assumed parameters, like desired temperature, bedewing of windows or external housing, water overflow from drip tray, and even compressor damage. These failures cannot be claimed by virtue of warranty.

## 3. Service Manual

### 3.1. Control panel – technical information:

#### Set point setting (desired temperature value)

The easy, easy compact and easy split devices control the desired temperature (set point) inside the cabinet or cold room directly and dynamically.

To view and modify the set point:

- press SET for 1s, the set value will start flashing;
- increase or decrease the value using UP or DOWN;
- press SET to confirm the new value.



**Manual defrost**

Not available on the easy thermometer (M) and easy compact models. Press DOWN for more than 3s (activated only if the temperature conditions are right , for easy split only if the light output is not set, H1=4). Alternatively, on easy split models, if the light output is set (H1=4), the defrost can be activated by pressing UP and DOWN together, when (H6=1).

### 3.2. Electrical chart

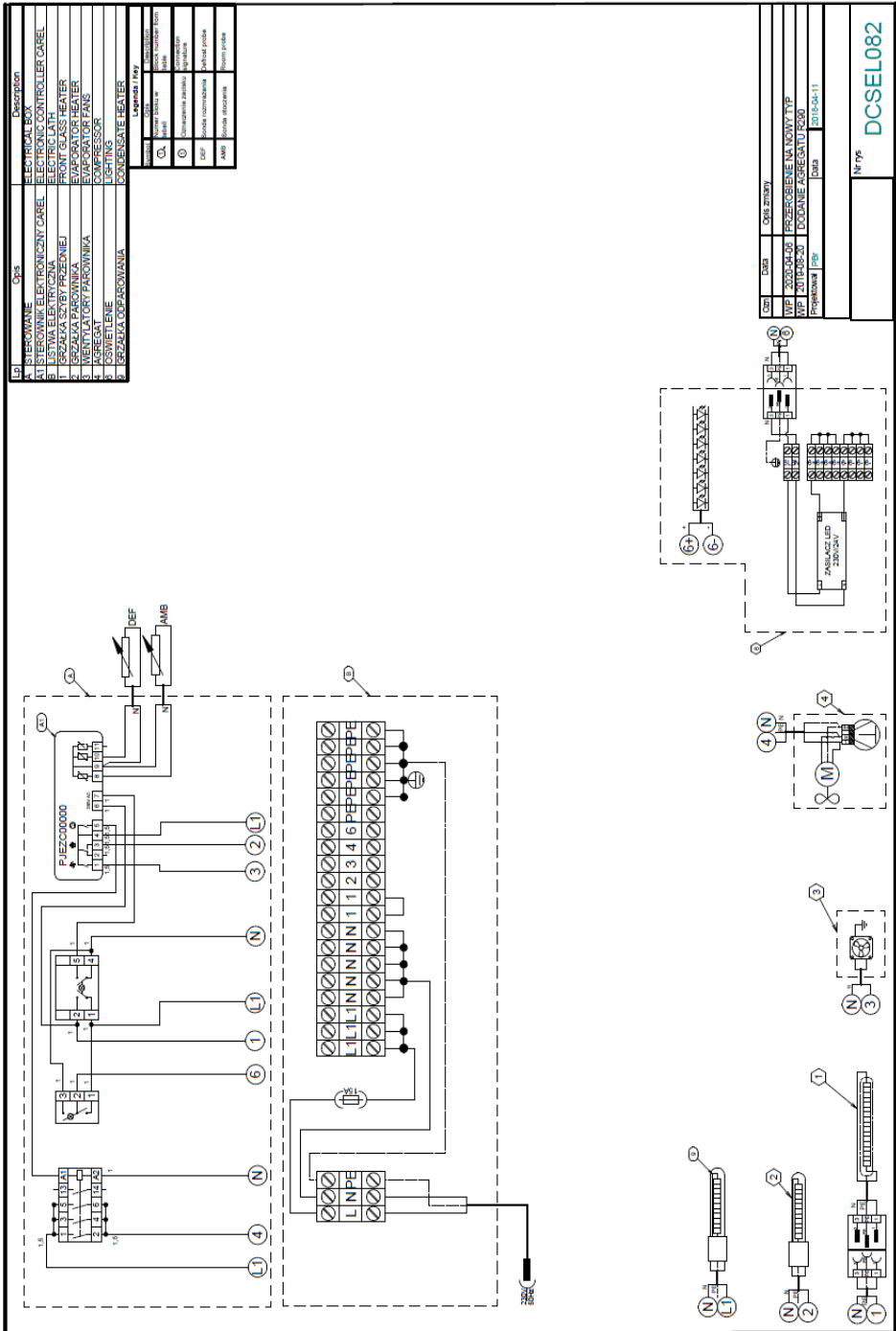

### 3.3. Parameters

Opis Description	Parametr Parameter	Wartość Value
Stabilność pomiaru Probe measurement stability	/2	4
Wybór czujnika wyświetlanego Probe display selection	/4	1
Wybór jednostek C/F Unit of measure C/F	/5	0
Punkt dziesiętny Decimal point	/6	0
Kalibracja sondy 1 Probe 1 offset	/C1	0
Kalibracja sondy 2 Probe 2 offset	/C2	0
Kalibracja sondy 3 Probe 3 offset	/C3	0
Punkty nastawy Set point	St	1
Dyferencjał punktu nastawy Control differential	rd	2
Minimalna wartość punktu nastawy Minimum set point value	r1	1
Maksymalna wartość punktu nastawy Maximum set point value	r2	5
Sterowanie normalne/odwrotne Select direct/reverse operation	r3	0
Delta trybu pracy nocnej Night-time set point delta	r4	3
Opóźnienie włączenia sprężarki i wentylatora po włączeniu zasilania Compressor and fan start delay on power-up	c0	0
Minimalny czas pomiędzy kolejnymi startami sprężarki Minimum time between cosecutive compressor starts	c1	0
Minimalny czas postoju sprężarki Minimum compressor off time	c2	2
Minimalny czas pracy sprężarki Minimum compressor on time	c3	0
Czas pracy sprężarki podczas awarii sondy Duty setting	c4	20
Czas trwania cyklu pracy ciągłej Continuous cycle duration	cc	2
Opóźnienie alarmu niskim temperatury po cyklu ciągłym Temperature alarm bypass after continuous cycle	c6	2
Typ odszraniania Type of defrost	d0	0
Interwał odszraniania Interval between defrost	dl	6
Temperatura końca odszraniania End defrost temperature set point	dt	6
Maksymalny czas trwania odszraniania Maximum defrost duration	dP	45

Odszranianie przy włączeniu zasilania Defrost on power-up	d4	0
Opóźnienie odszraniania po włączeniu urządzenia Defrost delay on power-up	d5	0
Wyświetlanie temperatury podczas odszraniania Freeze control temperature display during defrost	d6	1
Czas ociekania Dripping time	dd	6
Opóźnienie alarmu po cyklu odszraniania Alarm bypass time after defrost	d8	1
Nadrzędność odszraniania nad ochroną sprężarki Defrost priority over compressor protectors	d9	0
Odczyt czujnika odszraniania Defrost probe reading	d/	0
Podstawa czasu Time base	dC	0
Alarm i dyferencjał temperatury wentylatora Alarm and fan temperature differential	A0	-2
Alarm niskiej temperatury Low temperature alarm	AL	0
Alarm wysokiej temperatury High temperature alarm	AH	6
Opóźnienie alarmu temperaturowego Alarm temperature delay	Ad	120
Konfiguracja 3 wejścia cyfrowego 3rd input configuration	A4	0
Opóźnienie alarmu wejścia cyfrowego Digital input alarm delay	A7	0
Włączenie alarmu "Ed" Enable alarm ED - end defrost by timeout	A8	1
Punkt nastawy alarmu zabrudzonego skraplacza Condenser high temperature alarm set point	Ac	70
Dyferencjał temperatury alarmu zabrudzonego skraplacza High temperature condenser alarm differential	AE	5
Opóźnienie alarmu zabrudzonego skraplacza High temperature condenser alarm delay	Accd	0
Aktywacja sterowania wentylatorami parownika Enable evaporator fan control	F0	1
Punkt nastawy dla wentylatorów Evaporator fan control set point	F1	10
Zatrzymanie wentylatorów wraz ze sprężarką Stop evaporator fan if compressor off	F2	0
Status wentylatorów podczas odszraniania Evaporator fan status during defrost	F3	0
Opóźnienie włączenia wentylatora po ociekaniu Post-dripping time	Fd	0
Hasło Password	Pw	22
Adres w sieci monitoringu Serial address	H0	1

Konfiguracja wyjścia AUX AUX output configuration	H1	0
Aktywacja klawiszy Enable keypad	H2	1
Wyłączenie sygnału dźwiękowego Disable buzzer	H4	0
Kod ID Detect changed parameter	H5	0
<p>Powyższa lista zawiera zalecane parametry pracy urządzenia. Jednak z względu na różne warunki pracy można dokonać zmiany parametrów po wcześniejszym kontakcie z producentem urządzenia. Zmiana parametrów przeprowadzona bez konsultacji z producentem urządzenia może skutkować niewłaściwą jego pracą lub nawet jego uszkodzeniem, a w konsekwencji doprowadzić do utraty gwarancji.</p> <p>The above list consists of a recommended parameters of device operation. In view of different working conditions changes are possible to be introduced after prior contact with device producer.</p> <p>Changing parameters without contacting the device producer may cause incorrect work of or even device damage and in consequence you may lose your warranty.</p>		

Opis Description	Parametr Parameter	Wartość Value
Stabilność pomiaru Probe measurement stability	/2	4
Wybór czujnika wyświetlanego Probe display selection	/4	1
Wybór jednostek C/F Unit of measure C/F	/5	0
Punkt dziesiętny Decimal point	/6	0
Kalibracja sondy 1 Probe 1 offset	/C1	6,5
Kalibracja sondy 2 Probe 2 offset	/C2	0
Kalibracja sondy 3 Probe 3 offset	/C3	0
Punkty nastawy Set point	St	1
Dyferencjał punktu nastawy Control differential	rd	2
Minimalna wartość punktu nastawy Minimum set point value	r1	1
Maksymalna wartość punktu nastawy Maximum set point value	r2	5
Sterowanie normalne/odwrotne Select direct/reverse operation	r3	0
Delta trybu pracy nocnej Night-time set point delta	r4	3
Opóźnienie włączenia sprężarki i wentylatora po włączeniu zasilania Compressor and fan start delay on power-up	c0	0
Minimalny czas pomiędzy kolejnymi startami sprężarki Minimum time between cosecutive compressor starts	c1	0
Minimalny czas postoju sprężarki Minimum compressor off time	c2	2
Minimalny czas pracy sprężarki Minimum compressor on time	c3	0
Czas pracy sprężarki podczas awarii sondy Duty setting	c4	20
Czas trwania cyklu pracy ciągłej Continuous cycle duration	cc	2
Opóźnienie alarmu niskiej temperatury po cyklu ciągłym Temperature alarm bypass after continuous cycle	c6	2
Typ odszraniania Type of defrost	d0	0
Interwał odszraniania Interval between defrost	dl	4
Temperatura końca odszraniania End defrost temperature set point	dt	6
Maksymalny czas trwania odszraniania Maximum defrost duration	dP	45

Odszranianie przy włączeniu zasilania Defrost on power-up	d4	0
Opóźnienie odszraniania po włączeniu urządzenia Defrost delay on power-up	d5	0
Wyświetlanie temperatury podczas odszraniania Freeze control temperature display during defrost	d6	1
Czas ociekania Dripping time	dd	6
Opóźnienie alarmu po cyklu odszraniania Alarm bypass time after defrost	d8	1
Nadrzędność odszraniania nad ochroną sprężarki Defrost priority over compressor protectors	d9	0
Odczyt czujnika odszraniania Defrost probe reading	d/	0
Podstawa czasu Time base	dC	0
Alarm i dyferencjał temperatury wentylatora Alarm and fan temperature differential	A0	-2
Alarm niskiej temperatury Low temperature alarm	AL	0
Alarm wysokiej temperatury High temperature alarm	AH	6
Opóźnienie alarmu temperaturowego Alarm temperature delay	Ad	120
Konfiguracja 3 wejścia cyfrowego 3rd input configuration	A4	0
Opóźnienie alarmu wejścia cyfrowego Digital input alarm delay	A7	0
Włączenie alarmu "Ed" Enable alarm ED - end defrost by timeout	A8	1
Punkt nastawy alarmu zabrudzonego skraplacza Condenser high temperature alarm set point	Ac	70
Dyferencjał temperatury alarmu zabrudzonego skraplacza High temperature condenser alarm differential	AE	5
Opóźnienie alarmu zabrudzonego skraplacza High temperature condenser alarm delay	Acd	0
Aktywacja sterowania wentylatorami parownika Enable evaporator fan control	F0	1
Punkt nastawy dla wentylatorów Evaporator fan control set point	F1	10
Zatrzymanie wentylatorów wraz ze sprężarką Stop evaporator fan if compressor off	F2	0
Status wentylatorów podczas odszraniania Evaporator fan status during defrost	F3	0
Opóźnienie włączenia wentylatora po ociekaniu Post-dropping time	Fd	0
Hasło Password	Pw	22
Adres w sieci monitoringu Serial address	H0	1

Konfiguracja wyjścia AUX AUX output configuration	H1	0
Aktywacja klawiszy Enable keypad	H2	1
Wyłączenie sygnału dźwiękowego Disable buzzer	H4	0
Kod ID Detect changed parameter	H5	0
<p>Powyższa lista zawiera zalecane parametry pracy urządzenia. Jednak z względu na różne warunki pracy można dokonać zmiany parametrów po wcześniejszym kontakcie z producentem urządzenia. Zmiana parametrów przeprowadzona bez konsultacji z producentem urządzenia może skutkować niewłaściwą jego pracą lub nawet jego uszkodzeniem, a w konsekwencji doprowadzić do utraty gwarancji.</p> <p>The above list consists of a recommended parameters of device operation. In view of different working conditions changes are possible to be introduced after prior contact with device producer.</p> <p>Changing parameters without contacting the device producer may cause incorrect work of or even device damage and in consequence you may lose your warranty.</p>		



# **VIBOCOLD<sup>®</sup>**

**MORE THAN COOL**

The manufacturer reserves the right to change the parameters of the device and introducing different technical solutions.

The information contained in this document may be changed by the manufacturer without notice to the user.

Copying of this manual without permission is prohibited.

Pictures and drawings are for illustration only and may differ from your device